

Operating Instructions

AUTOMATIC TELEPHONE
ANSWERING SYSTEM

EASA-PHONE

Model No. **KX-T1450BA**

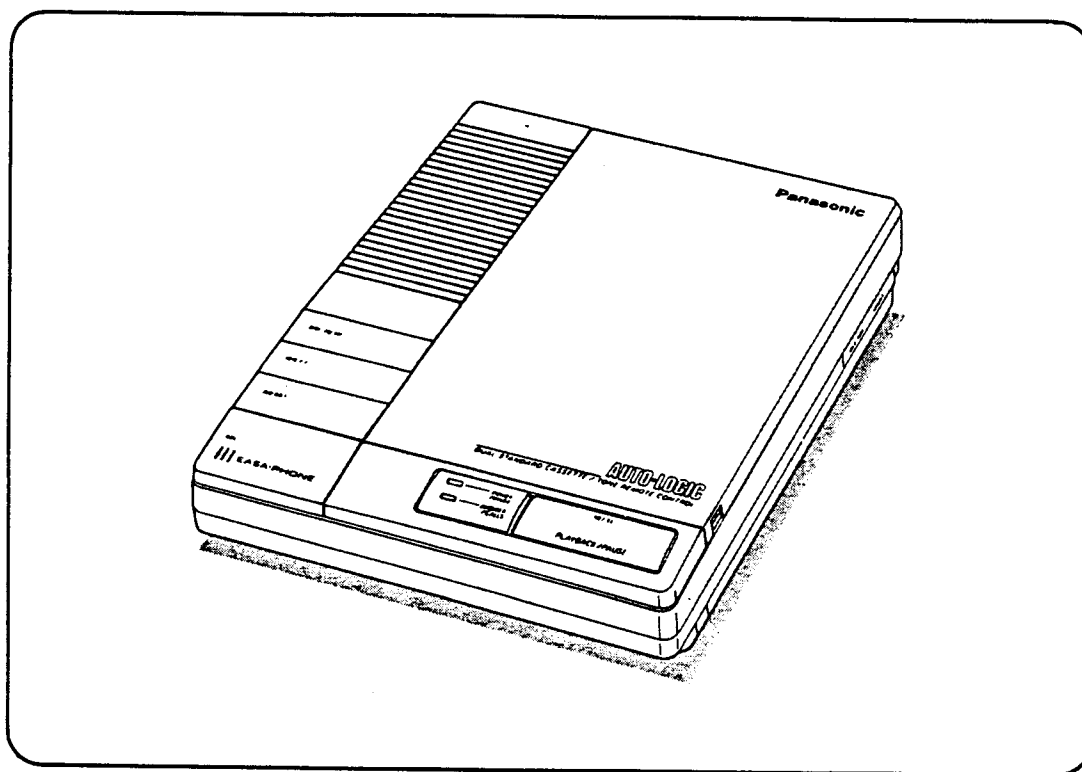

AUTO-LOGIC

Panasonic

Please read before use.

Introduction

Thank you for purchasing the Panasonic Telephone Answering System.

You can use this unit to:

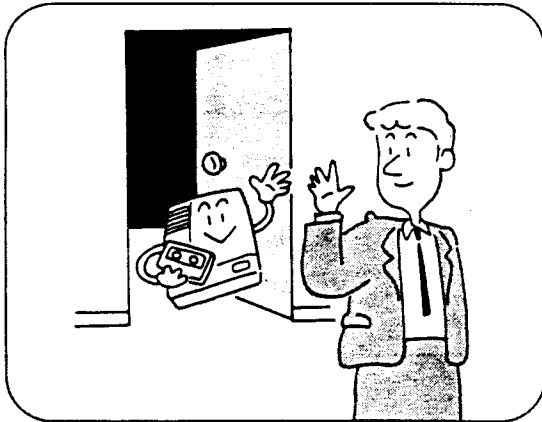

- Answer calls and record messages when you cannot answer the telephone or do not want to be disturbed
- Monitor (screen) calls
- Record message memo

By using the advanced remote-control features of this unit, you can also

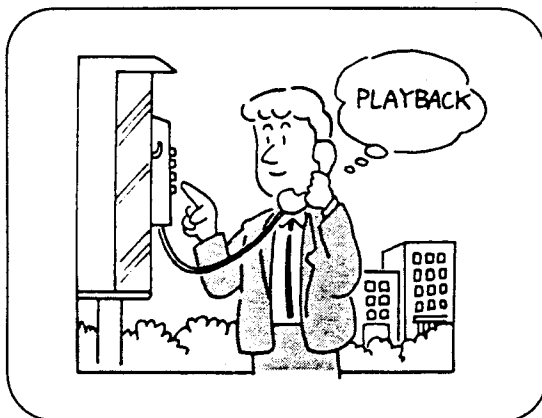

- Call in from another touch tone telephone to listen to your messages
- Record a new Outgoing Message even when you are away from your unit
- Leave messages while you are away from your unit

We recommend that you read these Operating Instructions all the way through before you set up and use your Answering System.

Accessories

- AC Adaptor one
- Telephone Cord one
- Outgoing Message Tape one
- Incoming Message Tape one

Table of Contents

Locations of the Controls and Connection	3
Preparation	
Initial Settings	4
Toll Saver	4
Cassette Tape Installation	5
Recording an Outgoing Message (OGM)	6
Setting Prior to Leaving	
Recording the Callers' Messages	8
Preparing the ICM Tape	8
Listening to the Recorded Messages	
Listening to the Messages	9
Re-playing Back All the Messages	9
Other Features	
Recording a Message Memo	10
Saving the Recorded Messages	11
Erasing the Recorded Messages	12
Monitoring the Incoming Calls	12
How to Operate from a Remote Phone	
Setting the Remote Code	13
Playing Back Messages	14
Playing Back Newly-Recorded Messages (Memory Playback)	14
Rewinding/Fast Forwarding the ICM Tape while Listening to the Messages	15
Recording a Marker Message	15
Resetting the ICM Tape for Future Messages	16
Monitoring Room Sound	16
Re-recording the Outgoing Message	17
Skipping OGM for ICM Recording	17
Setting/Canceling the Answer Mode	18
Troubleshooting Guide	19
Maintenance	20
Cassette Tape	21
Others	22

Location of the Controls and Connection

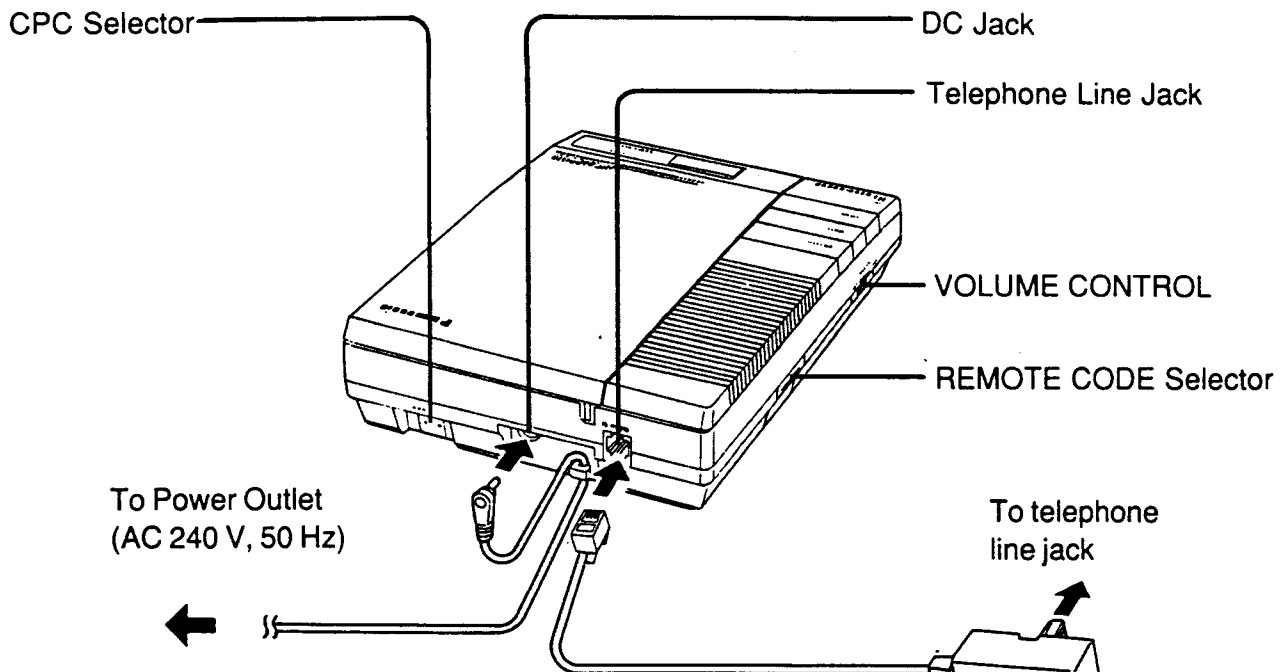
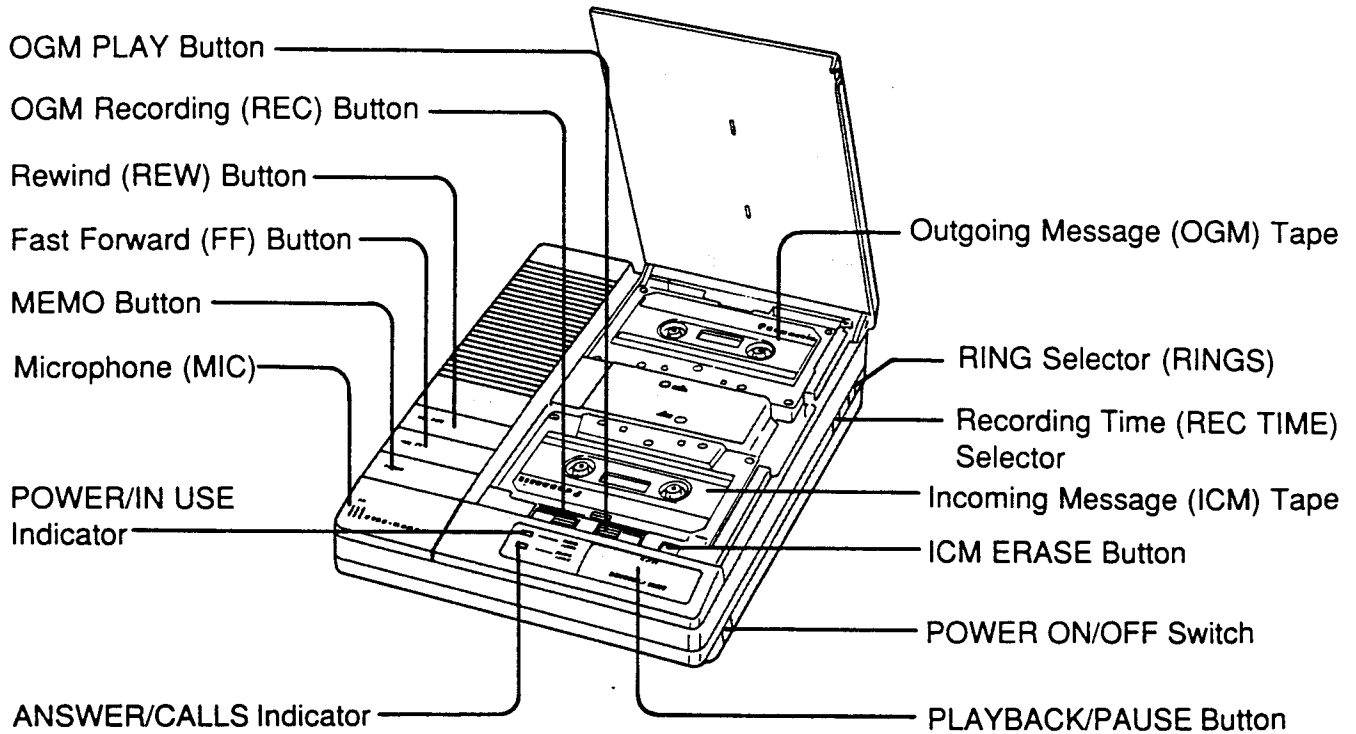

Do not connect the AC adaptor to the AC outlet before inserting the OGM and ICM tapes. (See page 6.)

- For the best results, use the included telephone cord.
- If you cannot connect this unit to your telephone line, consult your dealer.
- Use only the included AC Adaptor. (KX-A07BA or KX-A11BA)

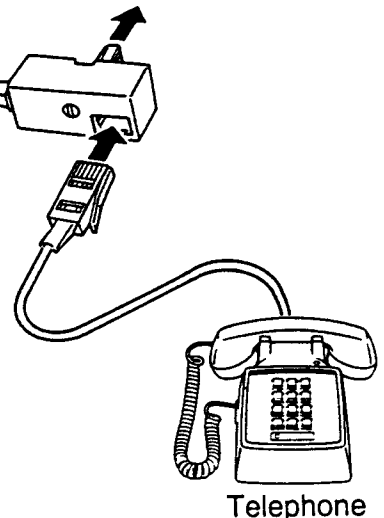

Preparation

Initial Settings

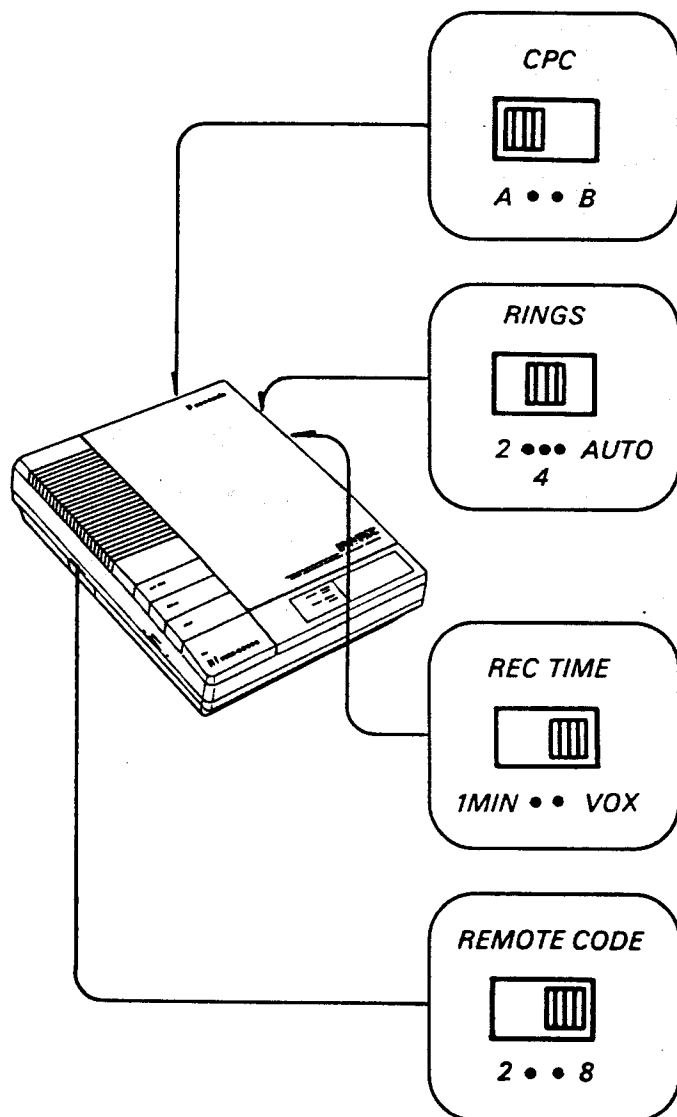

Calling Party Control (CPC) Setting

Set to "A". (no call waiting service line)

If you have call waiting service or some Incoming Messages are interrupted, set to "B".

Number of Rings

- 2..... The unit will answer a call on the second ring.
- 4..... The unit will answer a call on the fourth ring.
- AUTO..... See "Toll Saver" on this page.

Recording Time Selector

- VOX..... The unit will record for as long as the caller speaks.
- 1 minute.. The unit will record up to 1 minute. (1 MIN)

Remote Code

The remote code number is made up of 2 digits.

The first digit is factory preset, and the second digit is selectable. (2 or 8)

Also, refer to page 13 for your remote code setting.

Toll Saver

The TOLL SAVER feature lets you avoid a toll charge when you call your unit and no messages have been recorded.

1 Set the number of rings to **AUTO.**

- If the unit does not pick up on the third ring, hang up immediately. This means that you have no messages and you have saved a toll charge.

■ The unit picks up **on the second ring:**

It means that at least one message has been recorded.

- After you have played back all the messages from a remote phone, **the unit will pick up the next call on the fourth ring.** If the unit picks up on the second ring, it means that at least one new message has been recorded.

Cassette Tape Installation

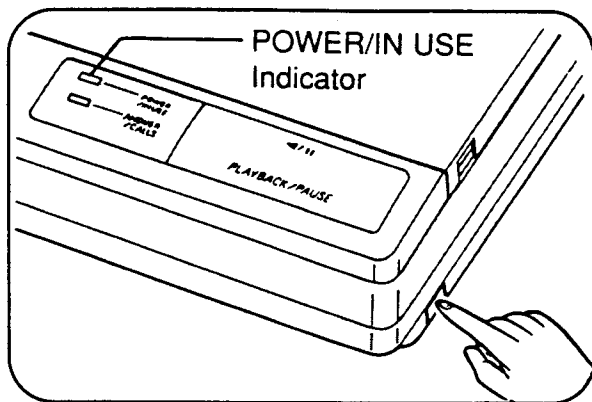
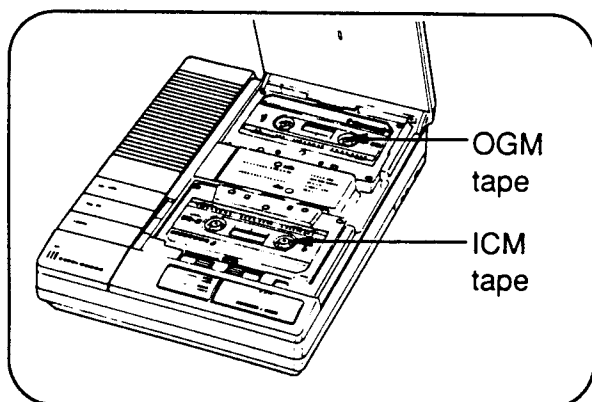

1 Open the panel, and insert the Outgoing Message (OGM) and Incoming Message (ICM) tapes as shown.

- Two cassette tapes are included. Use C15 for OGM and C60 for ICM.

2 Connect the AC adaptor to the AC outlet, then set the POWER ON/OFF switch to ON.

- The unit will start to reset the OGM tape.

NOTES:

- **3 minutes** after connecting the AC adaptor, the unit will be powered ON automatically and reset the OGM tape even when the **POWER ON/OFF** switch is not set to ON.
- **After you have changed the OGM tape:** Press **OGM PLAY** and **REW** simultaneously to reset the OGM tape.

Recording an Outgoing Message (OGM)

Before operating your unit, you must record an Outgoing Message (OGM). The OGM will inform the calling party of your absence and your message. Recording time may be any length up to the end of the tape.

Recording the OGM

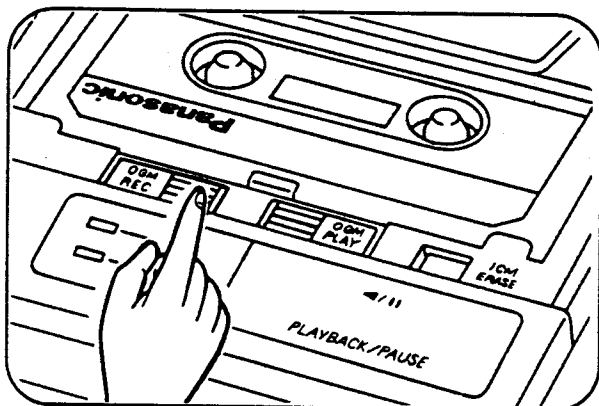

- 1 Press **OGM REC** until a long beep is heard, then release it.

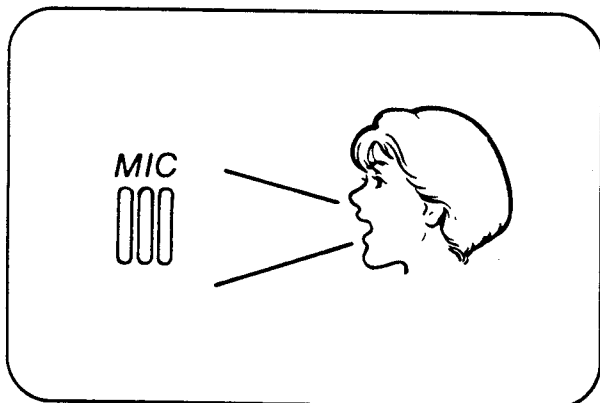

- 2 After the long beep, speak **clearly and loudly** into the microphone (MIC), from **approximately 20 cm (8")** away.

- Do not pause for over 2 seconds while recording.
- The IN USE indicator will flash.

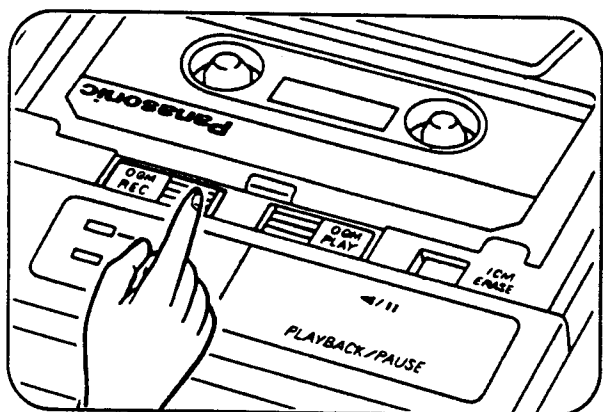

- 3 When recording is finished, press **OGM REC** again.

- The unit will rewind the tape to the beginning, and be ready for Incoming Calls.

NOTE:

If you pause for over 2 seconds while recording, you will hear a series of warning tones (6 beeps) and the unit will start rewinding the tape. If this happens, start with step 1 again after the unit stops rewinding.

Checking Your OGM

You can check your OGM at any time.

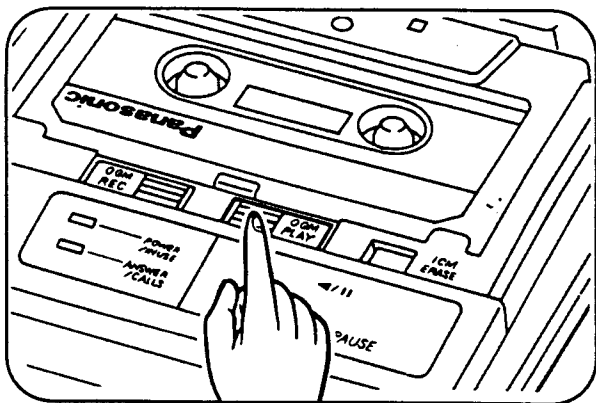

1 Press **OGM PLAY**.

- The unit will play back the OGM, then rewind the tape to the beginning.
- Use the **VOLUME** control on the left side of your unit to regulate the volume during playback if necessary.
- To stop the operation while playing back the OGM, press the **OGM PLAY** button.

NOTES:

- The unit will automatically change to the Answer mode 7 seconds after completing the OGM recording or checking.
- Answer mode:**
When a call is received, the unit will automatically answer and record Incoming Messages on the ICM tape.

Sample OGMs

When you have set the Recording Time to "VOX"

(For setting the recording time, see page 4):

"Hello, this is the Smith residence. We cannot come to the phone right now. If you would like us to call you back, please leave a message, including your name and telephone number after the beep. Thank you for calling."

"This is the Panasonic (your name or business) Sales Company. We are glad that you called but our office will open at 9 o'clock in the morning. If you leave a message, including your name and telephone number after the beep, we will return your call as soon as we can. Thank you."

When you have set the Recording Time to "1 min":

"Hello, this is (your name, business and/or telephone No.).
I am sorry I am not here to speak to you at the moment. Please leave a message after the beep. **You have up to 1 minute for recording.** Thank you."

Setting Prior to Leaving

Recording the Callers' Messages

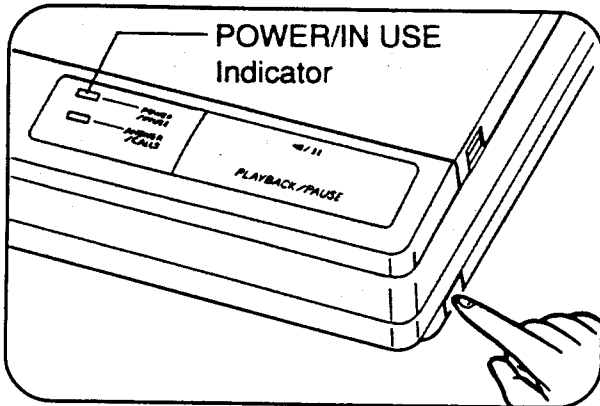

- 1 Press **POWER ON/OFF** to **ON**.
 - The **POWER** indicator will light.

NOTES:

- The unit will automatically switch itself to the Answer mode 7 seconds after you set the **POWER ON/OFF** switch or you complete some other operations. When the telephone rings, the unit will play back your OGM, then it will record the callers' messages on the tape.
- If you do not want to set the unit to the Answer mode, set the **POWER ON/OFF** switch to **OFF**.

Preparing the ICM Tape

After reviewing the Incoming Messages, the unit will automatically reset itself to the Answer mode.

- To record future messages after the last message; leave the unit as is. All calls will be saved.
- To record the future messages from the beginning of the tape;

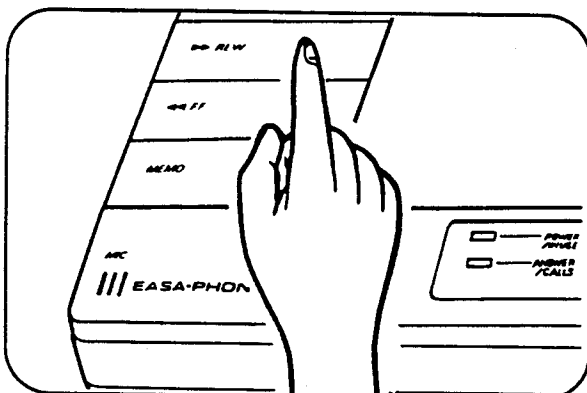

- 1 Press **REW**.

Listening to the Recorded Messages

- When an Incoming Message has been recorded, the ANSWER/CALLS indicator will flash. (Three flashes followed by a pause means that 3 messages were recorded.)
- In case of a power interruption, the ANSWER/CALLS indicator will flash slowly after the power is restored.

Listening to the Messages

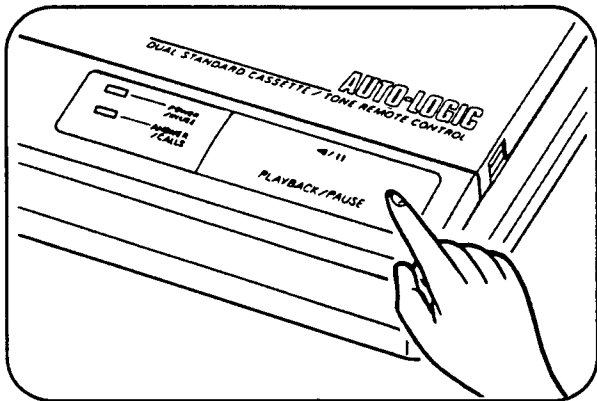

1 Press **PLAYBACK/PAUSE**.

- The playback volume is adjustable using the **VOLUME** control (left side on your unit).

AUTO-LOGIC (One-Touch Operation):

At the touch of the **PLAYBACK/PAUSE** button, the unit will automatically rewind and play back all the recorded messages. At the end of the last message, you will hear 3 beeps. After 7 seconds, the unit will reset itself to the Answer mode. All calls will be automatically saved.

- **Future Incoming Messages will be recorded after the last message.**
- **To record the future messages from the beginning of the tape, press the **REW** button.**
- **To stop the tape temporarily during playback, press the **PLAYBACK/PAUSE** button once. The IN USE indicator will flash. The tape will pause until you restart by pressing it again.**
- **To rewind the tape, press the **REW** button.**
- **To fast forward the tape, press the **FF** button.**

Re-playing Back All the Messages

- 1 Wait until the ANSWER/CALLS indicator is lit after playing back all the messages.
- 2 Press **PLAYBACK/PAUSE**.
 - The unit will play back all the recorded messages again.
 - If you press the **PLAYBACK/PAUSE** button before the ANSWER/CALLS indicator is lit, press the **REW** button to rewind the tape. Within 7 seconds after rewinding, press the **PLAYBACK/PAUSE** button to re-play back all the messages.

Other Features

Recording a Message Memo

You may record a message memo at home on the ICM tape. It will be heard by anyone retrieving messages from a remote phone.

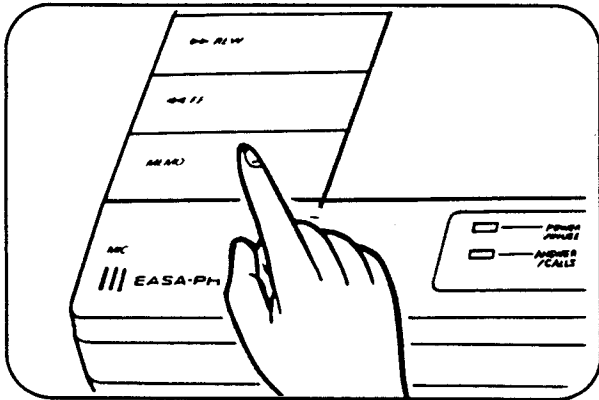

1 Press **MEMO** until a beep is heard.

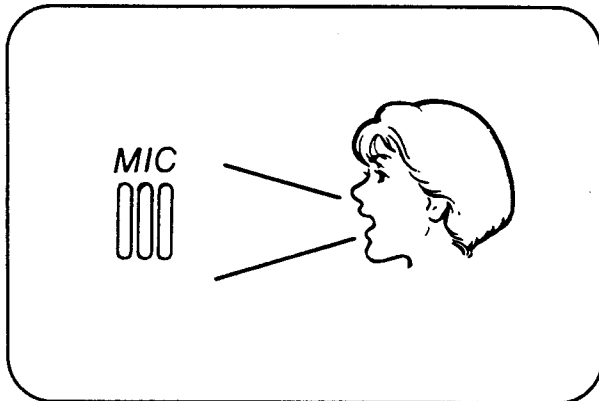

2 **Speak** into the MIC.

- The IN USE indicator will flash.

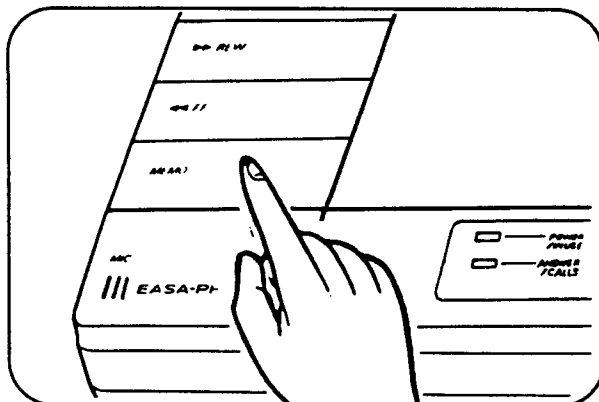

3 When finished recording, press **MEMO** again.

- The IN USE indicator will stop flashing.
- The ANSWER/CALLS indicator will flash to show that your message was recorded, and the unit will be ready to answer the phone call.
- New messages will be automatically recorded after your memo.

Saving the Recorded Messages

You can save the desired messages.

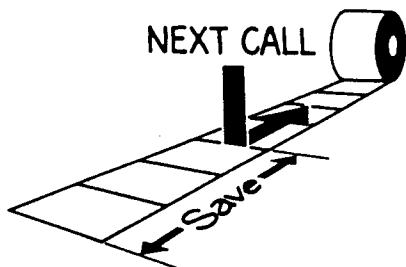

1 Play back the tape through the message you want to save.

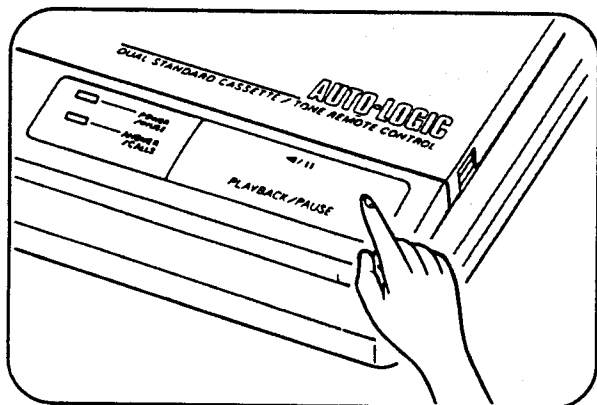

2 Press **PLAYBACK/PAUSE** to pause.

- The IN USE indicator will flash.

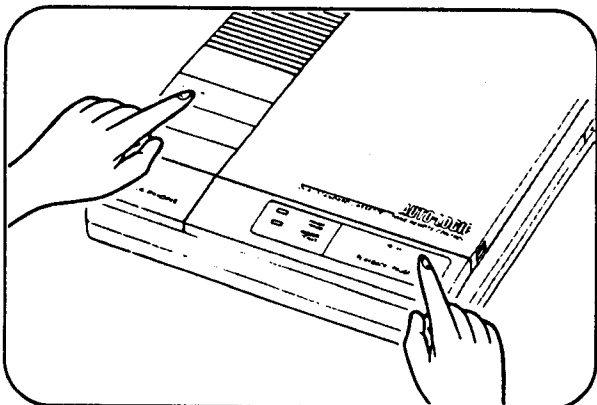

3 Press **PLAYBACK/PAUSE** and **REW** simultaneously.

- The IN USE indicator will stop flashing.
- The ANSWER/CALLS indicator will light.

Erasing the Recorded Messages

After you have played back the recorded messages, you can erase them by simply pressing the ICM ERASE button.

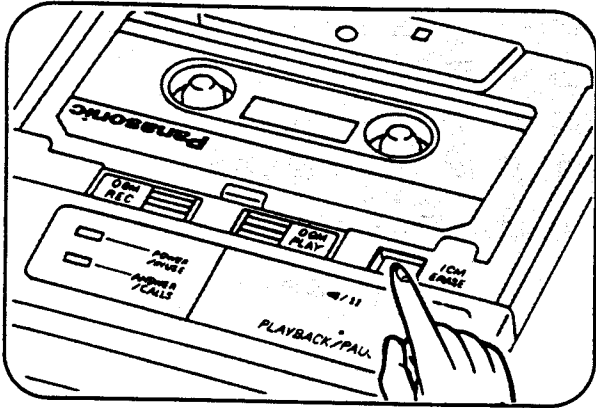

1 Press **ICM ERASE** until a beep is heard.

- The unit will erase the recorded messages while the tape is rewinding.

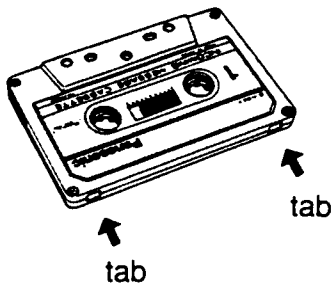

NOTE:

The tape can be erased even if the record-prevention (knock-out) tabs have been removed.

Monitoring the Incoming Calls

While an Incoming Message is being recorded, you can monitor it. Then you may choose to lift the telephone handset and speak to the caller directly.

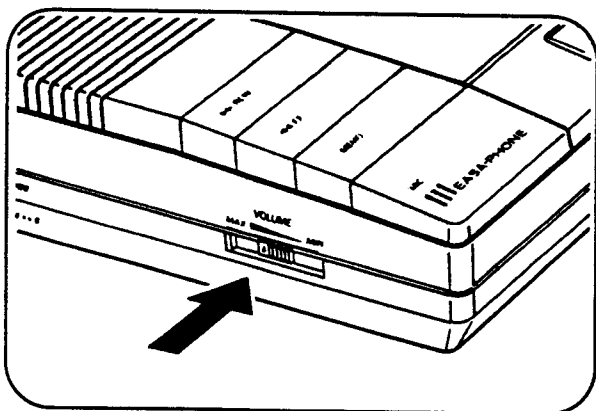

1 Adjust the volume control.

If you want to talk to the caller during recording of the ICM, lift the telephone handset and talk.

The unit will automatically stop recording and be ready to answer the next phone call.

How to Operate from a Remote Phone

On the following pages, we will explain following features:



- Playing Back Messages
- Playing Back Newly-Recorded Messages (Memory Playback)
- Rewinding/Fast Forwarding the ICM Tape while Listening to the Messages
- Recording a Marker Message
- Resetting the ICM Tape for Future Messages
- Monitoring Room Sound
- Re-recording the Outgoing Message
- Skipping OGM for ICM Recording
- Setting/Cancelling the Answer Mode

Setting the Remote Code

To get remote access, you must set and remember your remote code number. The REMOTE CODE number is made up of 2 digits, the first digit is factory preset, and the second digit is selectable. ("2" or "8")

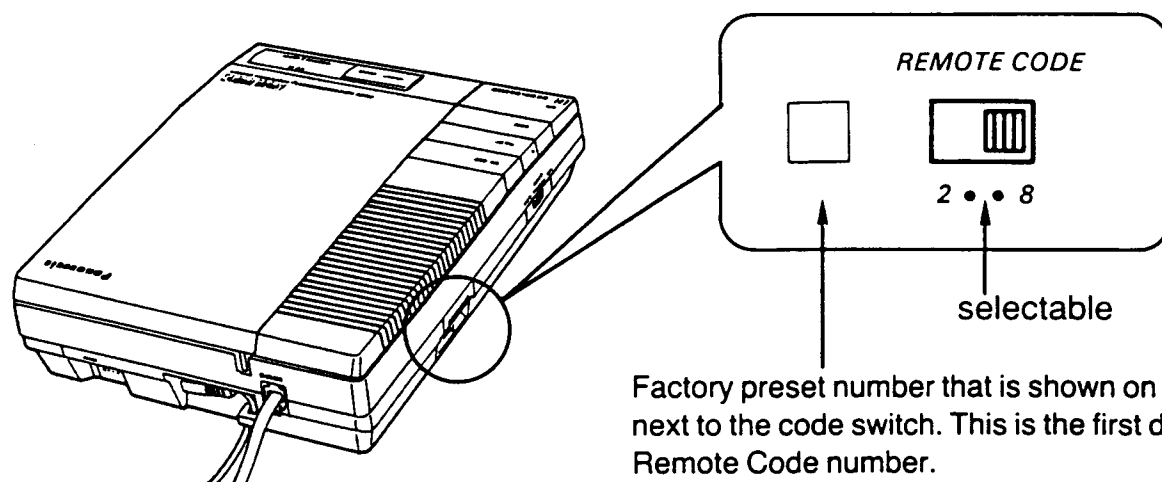

Factory preset number that is shown on the label next to the code switch. This is the first digit of your Remote Code number.

Example: If the factory preset number is "4", then your code number could be either "42" or "48" depending on the position of the REMOTE code switch.

Quick Reference Card for remote operation can be found on page 20. Detach the Card from the Operating Instructions and use it for your convenience.

Playing Back Messages

You can listen to the recorded messages **by simply pressing your own code number.**

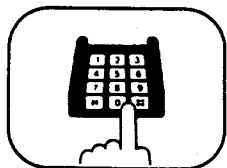

- 1 Call your unit, and press **the Code No.** (2 digits) during the OGM.
 - A beep will sound, then other beeps will sound to tell you the number of recorded messages, up to 8 times.
 - The unit will rewind the tape to the beginning. After a series of short beeps, you will hear all the messages on the tape.



- 2 Listen to the recorded messages.
 - 3 beeps will be heard after the last message.



- 3 Hang up.
 - All calls will be saved automatically.

Playing Back Newly-Recorded Messages (Memory Playback)

When you have already heard the messages from a remote phone, you can skip them and **listen to the newly-recorded messages.**

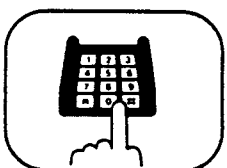

- 1 Call your unit, and press **the Code No.** during the OGM.



- 2 Press "4" right after you hear the beep tones indicating the number of the recorded messages.
 - The unit will play back the new messages.
 - Even during the playback of previously heard messages, you can skip them by pressing "4".

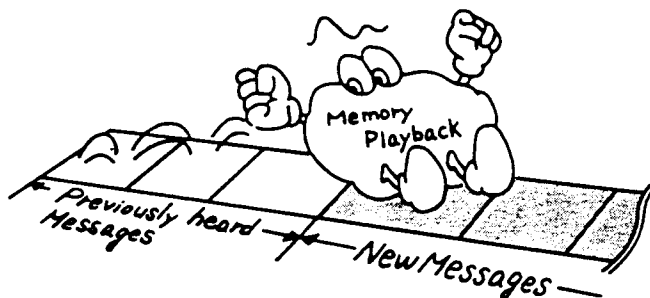

Rewinding/Fast Forwarding the ICM Tape while Listening to the Messages

To Back Space

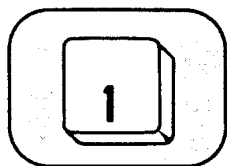

1 Press "1".

- The tape will be rewound for approximately 15 seconds corresponding to the playback time.

To Skip Forward

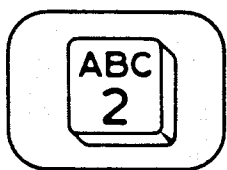

1 Press "2".

- The tape will be skipped forward for approximately 15 seconds corresponding to the playback time.

Recording a Marker Message

After reviewing all the messages, you can leave your index message on the tape. It will be heard by anyone retrieving messages.

1 Start to talk right after the last 2 beeps.

2 When recording is finished, hang up.

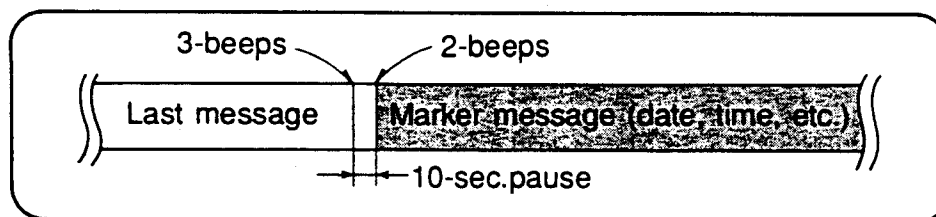

Resetting the ICM Tape for Future Messages

To record new Incoming Messages from the beginning of the tape, **after the recorded messages are played back or while they are being played;**

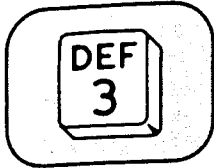

- 1 Press "3".
 - The unit will rewind the tape to the beginning and a beep tone will be heard when the tape has been reset.

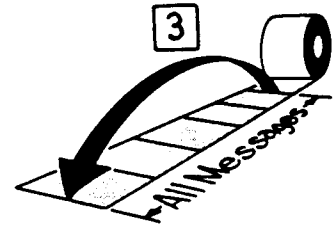

After all the messages have been played back.

If you have used Memory Playback

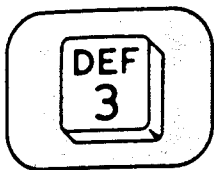

- 1 Press "3".
 - The unit will rewind the tape to the beginning of the **newly-recorded messages** and a beep will be heard.

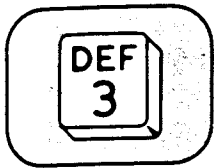

- 2 Press "3" again.
 - A beep tone will be heard and the future messages will be recorded from the beginning of the ICM tape.

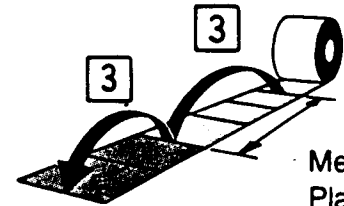

After you have used the Memory Playback.

If you have reset the tape by mistake

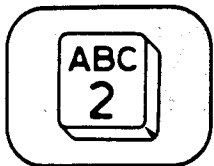

- 1 Press "2" after the tape has been reset (one-beep), then hang up.
 - The unit will advance the tape to the end of the recorded messages.

Monitoring Room Sound

You can monitor sounds in the room where the unit is installed.

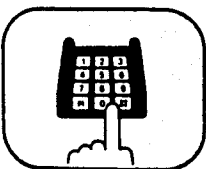

- 1 Call your unit and press the **Code No.** during the OGM.

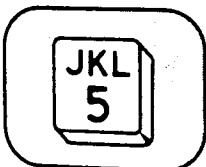

- 2 Press "5" right after you hear the beep tones indicating the number of the recorded messages.
 - You can listen for 30 seconds.
 - To listen further, press "5" again within 10 seconds of hearing one beep.

Re-recording the Outgoing Message

You can re-record the Outgoing Message from a remote phone.

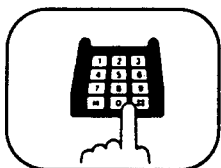

- 1 Call your unit, and press the **Code No.** during the OGM.

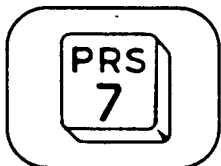

- 2 Press "7" right after you hear the beep tones indicating the number of recorded messages.
 - Short beeps will be heard continuously until the OGM tape has been reset, and then a long beep will be heard.



- 3 Speak clearly and loudly after you hear the long beep.
 - Do not pause for over 2 seconds while recording.

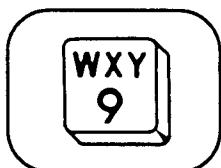

- 4 When recording is finished, press "9".
 - The new Outgoing Message will be played back. So you can check or amend it.

NOTE:

If you pause for over 2 seconds while recording, you will hear a series of warning tones (6 beeps). If this happens, repeat from step 2 within 10 seconds of hearing these beeps.

Skipping OGM for ICM Recording

If you or the caller does not want to hear the Outgoing Message, the unit **can be switched promptly to the Incoming Message mode.**



- 1 Call your unit.



- 2 Press "*" during the OGM.



- 3 **Speak** clearly and loudly after you hear the long beep to record your Incoming Message.

Setting/Cancelling the Answer Mode

You can easily set or cancel the Answer mode from a remote phone.

To Set

When you forgot to set the unit to the Answer mode:

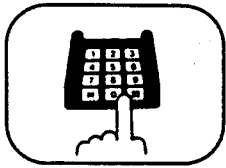

1 Call your unit.

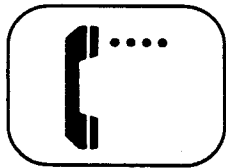

2 Wait for **15 rings**, the unit will answer.
●OGM will be heard, then hang up.
●The unit will be ready for recording incoming calls.

To Cancel

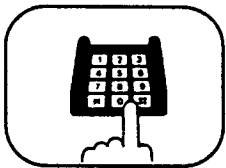

1 Call your unit, and press the **Code No.** during the OGM.



2 Press "0".
●The unit will not pick up any calls.

Troubleshooting Guide

Problem

Cause & Remedy

<ul style="list-style-type: none">●The unit does not work when I press any buttons.●I cannot remove the cassette from the unit.	Plug in the AC adaptor then switch the power on.
The unit has been set to the Answer mode, but no Incoming Messages are recorded.	<ul style="list-style-type: none">●The OGM or ICM cassette is cut or is not inserted. Replace the cassette with a new one.●The OGM is recorded improperly. Record a new OGM.
The unit does not function. However, the beep sounds 6 times and the ANSWER/CALLS indicator flashes on and off quickly.	<ul style="list-style-type: none">●OGM cassette might be broken. Replace it with a new one.●Clean the heads. (See page 20.)
While recording an Outgoing Message, the beep sounds 6 times.	Re-record your Outgoing Message. Speak clearly and loudly, and do not pause for over 2 seconds while recording.
When the Outgoing Message or the Incoming Message tape is played back, the sound level is low, even if the VOLUME control is turned up fully.	<ul style="list-style-type: none">●Clean the Heads. (See Maintenance instruction on page 20).
I have played back all the recorded messages and I want to record the next phone call after the last previously recorded message.	<ul style="list-style-type: none">●Wait for 7 seconds. The unit will be ready to record the next phone call.●In case of the remote operation, just hang up.
I press the button of a remote phone, but the unit does not respond.	<ul style="list-style-type: none">●Make sure that you are entering your correct Code number.●Record the Outgoing Message in a quiet place.
Some Incoming Messages have not been recorded up to their end.	Set the CPC switch to "B". (See page 4.)
The ICM tape continues to run after a caller hangs up.	Set the recording time selector to "1 MIN".

Maintenance

Because the head and capstan assemblies are in contact with the tape, dirt and residue from the tape can easily adhere to these parts, causing distortion. These parts should be cleaned periodically in the manner described below.

- **Clean the head surface, pinch roller and capstan with a cotton swab.**
If these surfaces are extremely dirty, dampen the cotton swab with alcohol.

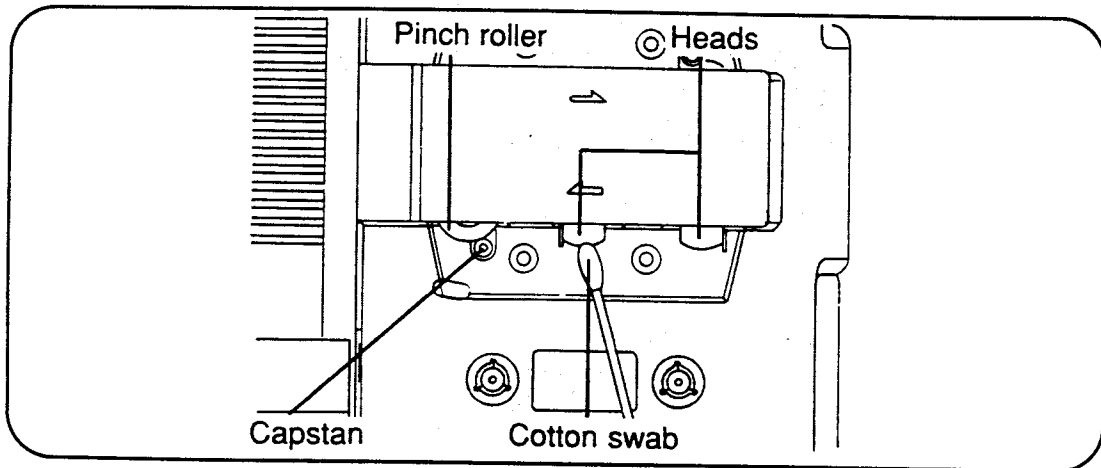

- Do not bring magnetic or metal objects, such as a screwdriver, near the head assemblies, as such objects could magnetize the heads.
- Do not oil any part of the unit.

QUICK REFERENCE CARD FOR TONE REMOTE CONTROL

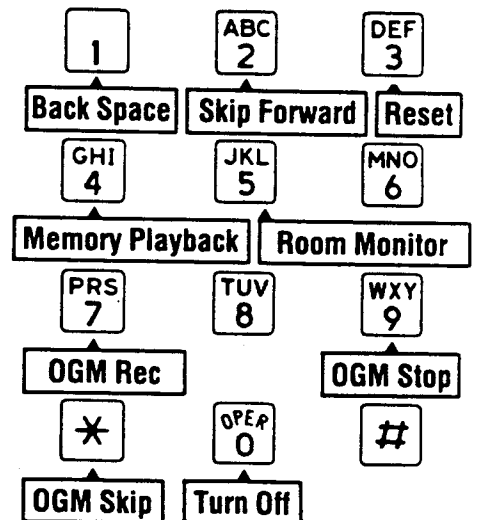

- To set Answer mode remotely, call your unit and wait for 15 rings. The unit will answer, then hang up.
- To turn off the unit remotely, push Code No. → push 0 → hang up.
- When you push a button, push firmly.

Cassette Tape

- For optimum sound quality and performance, we recommend that you re-record your OGM every three months, use side two after six months and replace the tape every year assuming that the unit answers about ten calls a day.
- Should the Incoming Message cassette tape break or become worn, replace it with a high quality "NORMAL" tape. Use Panasonic (C15, C30, C60, C90), or other high quality tape. Metal or chrome tape cannot be used.
- Never place a cassette tape near a magnetic source, such as a magnet or a TV set, because it may erase the tape.
- Slack in the tape can be tightened by rotating the tape reel with a pencil, as shown.

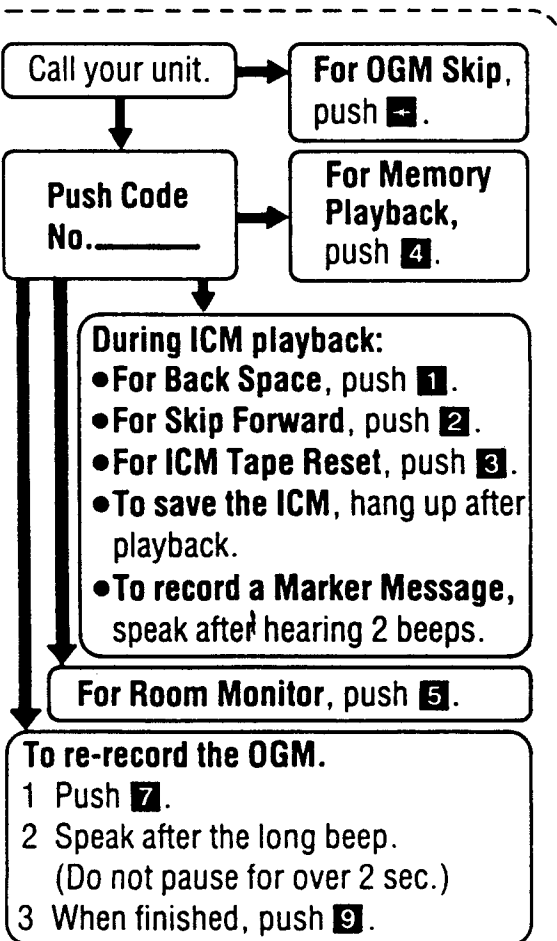
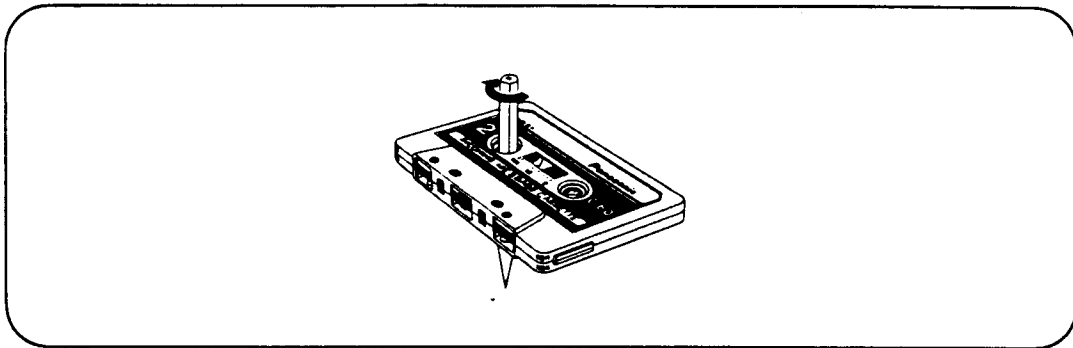

Others

- If there is any trouble, disconnect the unit from the telephone line and connect a known working phone. If the known working phone operates properly, have your Panasonic unit repaired. If the known working telephone does not operate properly, consult with your telephone company.
- Do not use benzine, thinner, or similar solvents. Do not use abrasive powder to clean the cabinet. Wipe it with a soft cloth.
- Keep the unit away from heating appliances and electrical noise generating devices such as fluorescent lamps, motors and television. These noise sources can interfere with the performance of the unit.
- The unit should be kept free of dust, moisture, high temperature and vibration, and should not be exposed to direct sunlight.
- Never attempt to insert wires, pins, etc. into the vents or other holes of this unit.

